

MUNDIAL

INDUSTRIAL PLUGS AND SOCKETS

Description: IP66-IP67 SLOPING FLUSH-FIT SOCKET 3P+E 380V 32A 6H

Reference:

03805

Characteristics:

Product type:	Low voltage sloping flush-fit socket
Current:	32A
Poles:	3P+E
Voltage:	380/415 V
Frecuency(Hz):	-
Time code:	6
Colour:	Red
Weight (kg):	1,51
Dimensions:	
Materials:	Halogen-free plastic materials. Plastic parts: polyamide 6. Contacts: copper-zinc alloy
Packaging units:	6

Technical data:

Degree of protection:	IP66-IP67
Degree of protection remarks:	
Resistance to impact:	IK08
Glow wire resistance:	960 °C
Ball pressure test:	125 °C
Ambient temperature range:	-25 °C / +40 °C

Certifications and norms:

Directive:	2014/35/EU
Standards:	IEC 60309-1-2
Certificates:	



Codes:

EAN:	8431044038056
Customs tariff number:	85.36.69.90
ETIM 8.0:	EC001317

MUNDIAL

INDUSTRIAL PLUGS AND SOCKETS

Description: IP66-IP67 SLOPING FLUSH-FIT SOCKET 3P+E 380V 32A 6H

Reference: 03805

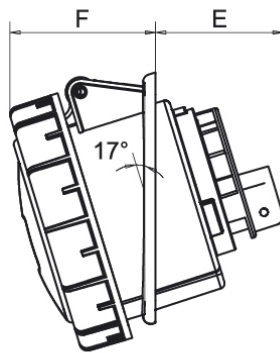
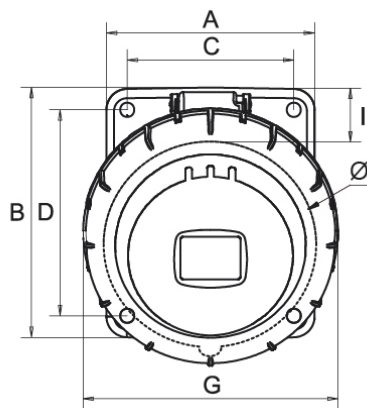

Dimensions:

I	Poles	Dimensions								
		A	B	C	D	E	F	G	I	Ø
16 A	2P+E	66	83	50	65	43	50	69	17	53
	3P+E	66	83	50	65	43	50	77	14	60
	3P+N+E	80	98	64	79	43	50	89	15	66
32A	2P+E	80	96	64	79	50	56	89	14	68
	3P+E	80	96	64	79	50	56	89	14	68
	3P+N+E	80	96	64	79	50	56	98	11	74
63 A	2P+E	100	112	80	88	64	80	109	-	92x82
	3P+E	100	112	80	88	64	80	109	-	92x82
	3P+N+E	100	112	80	88	64	80	109	-	92x82
125A	2P+E	120	130	100	108	92	77	124	-	102x90
	3P+E	120	130	100	108	92	77	124	-	102x90
	3P+N+E	120	130	100	108	92	77	124	-	102x90

Sustainability:

RoHS - REACH

Product end of life stage:

Product concerned in the WEEE regulations.

Supply:

Supplied in a single box per packaging multiple